

INSTALLATION INSTRUCTIONS

GRAVITY Marine Deck Lighting



**Important: Read all instructions prior to installation.
Do not over tighten the fasteners when installing.**

Parts Included

- 1 x Gravity Series Light
- 1 x Instructions
- 1 x Faceplate (Surface Mount /Dome /Cone /Eyelid)
- 2 x Stainless Steel Screws
- 2 x Screw Anchors

Wiring Diagram Single Color

FIGURE 1

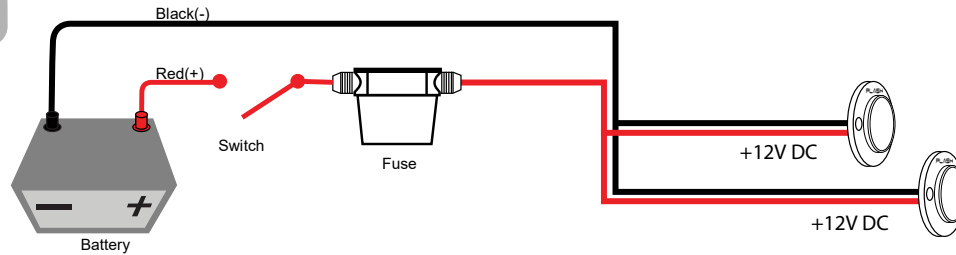

Wiring Diagram RGB

FIGURE 2

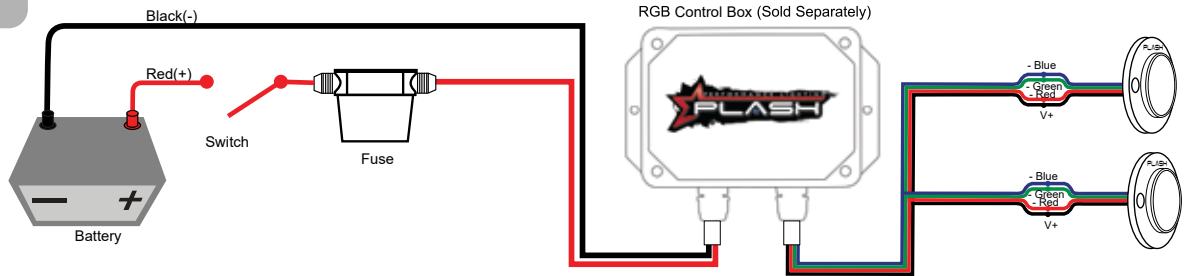

Dimension Diagram

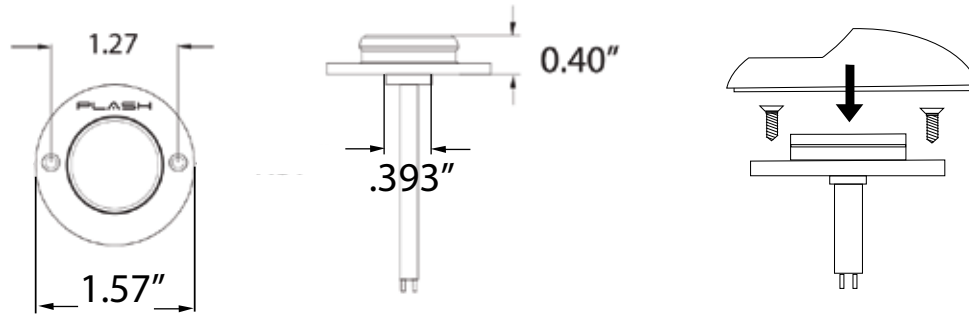

- 1) Non-compliance of these instructions may cause damage to the lights or injury, and will also invalidate our limited lifetime warranty.
- 2) The installation must be carried out by qualified personnel in accordance with local and national codes.
- 3) Regularly inspect the lights, power wire, connections, and any other accessories. If any part is damaged, the product should not be installed.
- 4) Disconnect the power supply before installation and service.
- 5) Install and use these fixtures in the proper location as to avoid damage to the light fixtures.
- 6) Verify that the connecting wires from lighting fixtures align to the proper matching poles before powering on.
- 7) Do not install light fixtures in low areas where water can collect or otherwise get into the fixtures.
- 8) Keep this instruction manual handy for future use.
- 9) If using a driver, the driver must be an electronic switching power supply with constant voltage output.
- 10) The light source of this product are not changeable or replaceable.
- 11) Do not disassemble the product.
- 12) Apply power to the lights to test prior to installation.
- 13) Always use the proper fuse size.
- 14) If extending the power wire refer to American Wire Gauge and AYBC for wire size (gauge).
- 15) **Over voltage by little as >3V may cause permanent damage to the light.**
- 16) **Ensure the power wire close to the fixture is secured and not capable of movement as this may damage the seal into the light.**
- 17) **Do not use excessive water pressure to clean. Such as from a pressure washer, as this may damage the fixture.**

*****DISCLAIMER*****

These instructions are designed to provide a simple and straight forward installation of your Gravity Series Marine Deck Lights. Plashlights LLC., is not responsible for any damage resulting from the improper installation of these Gravity Series Marine Deck Lights to your vessel, components, or to location of installation.

**For Technical Questions Please Call: 1-855-661-1002 Ext. 3
Mon-Fri 10am-5pm CST**

SPECIFICATIONS

- Item No.: UL-1014
- Input: ****See specific label on power wire for voltage.****
- Power: 1.2W
- Amp Draw: 0.2A@12V DC
- Lamp type: 1 PC 1W OSRAM LED
- Beam angle; 120°
- IP rating: IP67
- Warranty: Limited Lifetime

INSTALLATION INSTRUCTIONS

STEP 1

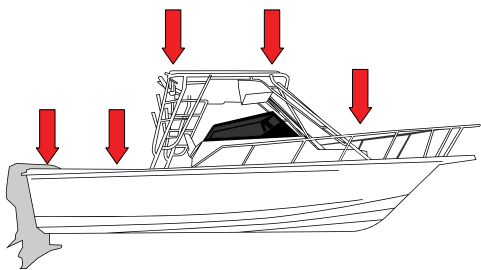

Begin by deciding on the installation point for your new accent light.

STEP 2

Disconnect the battery or Isolate your power supply

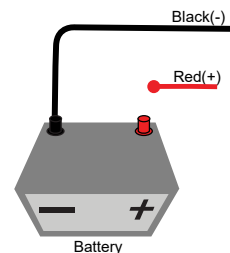

STEP 3

Drill the hole for the power wire to also accommodate part of the housing. 3/8" hole (10mm). Drill two holes with a 7/32" bit for the screw anchors.

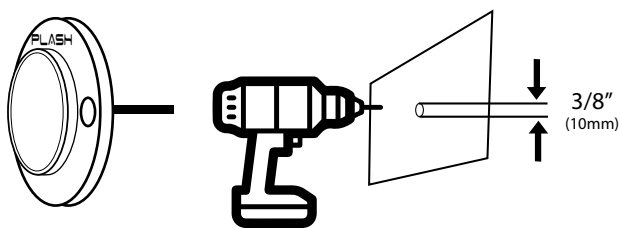

STEP 4

Feed the power wire through the center hole you just drilled. You may then insert the screw anchors into the adjacent holes. Use a low torque setting if using power tools. Ensure the power wire close to the fixture is secured and not capable of movement as this may damage the seal into the light.

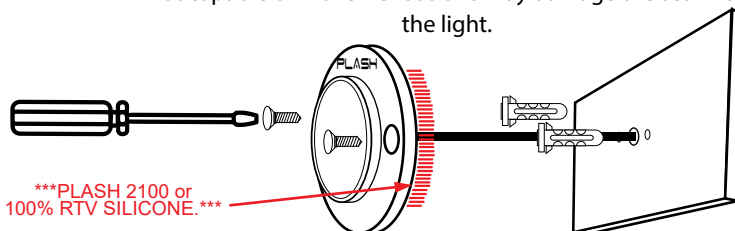

STEP 5A

Use IP67 or IP68 waterproof connectors or solder to connect the wire from the light to the circuit..

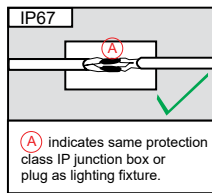
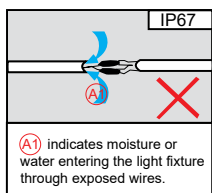

STEP 5B

Make sure your lights are fuse protected.

Connect your wiring to the appropriate fuse block, fixtures and power supply / battery.

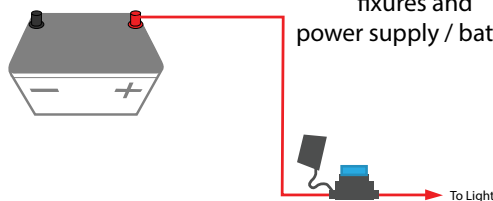

STEP 6

Push the cover onto the light body, it will "snap" into place and be held by a silicone O-ring..

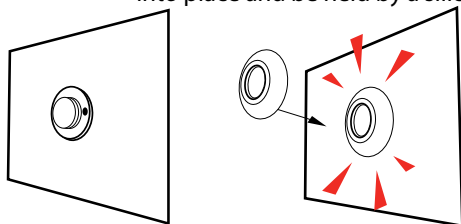

STEP 7

A) Verify the install, insuring the wires are not cut, pinched nor installed improperly.

B) Power on and test for functionality.